

---

# Trans-Blot Turbo Transfer System

## Instruction Manual

Catalog #1704150



**BIO-RAD**



## Bio-Rad Technical Support

The Bio-Rad Technical Support department is open Monday through Friday, 5:00 AM to 5:00 PM, Pacific time.

Phone: 1-800-424-6723, option 2

Email: Support@Bio-Rad.com (U.S./Canada only)

For technical assistance outside the U.S. and Canada, contact your local technical support office or click the Contact us at [www.bio-rad.com](http://www.bio-rad.com).

## Legal Notices

No part of this publication may be reproduced or transmitted in any form or by any means, electronic or mechanical, including photocopy, recording, or any information storage or retrieval system, without permission in writing from Bio-Rad Laboratories.

Bio-Rad reserves the right to modify its products and services at any time. This user guide is subject to change without notice.

Although prepared to ensure accuracy, Bio-Rad assumes no liability for errors, or for any damage resulting from the application or use of this information.

Chemiluminescent substrate technology is protected by U.S. Patent Number 6,432,662.

Clarity Max Western ECL Substrate is manufactured by Cyanagen Srl and is the subject of patent application numbers US7855287, EP1950207, US9040252, AU2011202658, CA2742025, US8129136, and EP1962095, together with other equivalent granted patents and patent applications in other countries like CN102313732.

Precision Plus Protein Standards are sold under license from Life Technologies Corporation, Carlsbad, CA for use only by the buyer of the product. The buyer is not authorized to sell or resell this product or its components.

Bio-Rad, Trans-Blot, and Mini-PROTEAN are trademarks of Bio-Rad Laboratories, Inc. in certain jurisdictions. All trademarks used herein are the property of their respective owner.

## Safety Warnings



**Warning:** Do not open or attempt to repair the Trans-Blot Turbo instrument or cassettes. Doing so will void your warranties and can put you at risk for electric shock. Return the Trans-Blot Turbo instrument or cassettes to the factory (U.S. customers) or to an authorized distributor (all other customers) if repairs are needed.



Under normal operating conditions, Trans-Blot Turbo cassettes may become warm during transfer.



Clean and inspect the instrument and cassette after each use for damage. Contact Bio-Rad technical support if any damage is noted.



Install and operate the Trans-Blot Turbo Transfer System in a clean and dry location away from excess moisture. During operation, avoid using excessive buffer in or around the instrument.

## Safety Compliance

This instrument has been tested and found to be in compliance with all applicable requirements of the following safety and electromagnetic standards:

- EN61010-1 Electrical Equipment for Measurement, Control, and Laboratory Use
- UL STD No. 61010A-1 Electrical Equipment for Measurement, Control, and Laboratory Use, Part 1: General Requirements
- CAN/CSA C22.2 No. 61010-1-04 Safety Requirements for Measurement, Control, and Laboratory Use, Part 1: General Requirements (includes Amendment 1)
- IEC 61010-1 Safety Requirements for Measurement, Control, and Laboratory Use, Part 1 General Requirements

## Electromagnetic Compatibility (EMC)

EN61326 Class A Electrical Equipment for Measurement, Control, and Laboratory Use, General Requirements

## FCC Warning and Notes

**Warning:** Changes or modification to this unit not expressly approved by the party responsible for compliance could void the user's authority to operate the equipment.

This Bio-Rad instrument is designed and certified to meet EN61010\* and the EMC requirements of EN61326 (for class A) safety standards. Certified products are safe to use when operated in accordance with the instruction manual. This instrument should not be modified or altered in any way. Alteration of this instrument will:

- Void the manufacturer's warranty
- Void the EN61010 safety certification
- Create a potential safety hazard

\* EN 61010 is an internationally accepted electrical safety standard for laboratory instruments.

Bio-Rad Laboratories is not responsible for any injury or damage caused by the use of this instrument for purposes other than those for which it is intended, or by modifications of the instrument not performed by Bio-Rad Laboratories or an authorized agent.

We strongly recommend that you follow the safety specifications listed in this section and throughout this manual. Use only the supplied power cord with the instrument, making sure to choose the plug adaptor that corresponds to the electrical outlets in your region.

## Specifications

### Trans-Blot Turbo Instrument

Dimensions: (L x W x H) 26.0 x 21.1 x 20.4 cm

Weight: 8 lb with cassettes, 4.5 lb without cassettes

Input power: 100–240 VAC, 276 VA, 50–60 Hz, 175 W max

Fuses: Two 6.3 A, 250 V, fuses located above the power connection

On/off switch: Yes, mains connected

USB port: Yes, input only, for firmware updates

Cooling fan: Yes

Output power: 0–26 VAC (1 V increments), 0–2.6 A DC (0.1 A increments) for each cassette

Operating conditions: 15–31°C ambient temperature, 0–95% relative humidity (noncondensing)

**Note:** User protocol settings are limited to 1–25 V (1 V increments), 1–2.5 A (0.1 A increments)

### User Interface

18 button keypad, 128 x 64 pixel monochrome display

Programmable methods: Up to 25 user defined

Preprogrammed methods: Standard SD, 1.5 mm gels, High MW, Low MW, Mixed MW, 1 Mini-PROTEAN TGX Gel

Audible alarm: Yes

User notifications:

- Power fail during run
- No load detection
- No cassette detection
- End of run
- Watt/hr limit

### Trans-Blot Turbo Cassettes

Dimensions: (L x W x H) 20.2 x 16.0 x 4.5 cm

Anode: Platinized titanium electrode plate

Cathode: Stainless steel

Weight: 1.5 lb

## Gel Compatibility

Suitable for transfer of two mini format gels or one midi format gel per cassette. Other gel sizes can be trimmed to fit the consumable transfer packs.

## Trans-Blot Transfer Packs

Tray dimensions (L x W): 18.0 x 14.5 cm

Stack dimensions (L x W): Mini format (7.0 x 8.5 cm), midi format (13.5 x 8.5 cm), + tab

Pad materials and buffer: proprietary

Membrane: 0.2  $\mu\text{m}$  nitrocellulose or 0.2  $\mu\text{m}$  PVDF

**Note:** Tray base is polyethylene terephthalate glycol (PETG) and can be recycled according to local regulations for class 1 plastics.

## Trans-Blot Turbo RTA Transfer Kits

Membrane dimensions (L x W): Mini format (7.0 x 8.5 cm), midi format (13.5 x 8.5 cm)

Membrane: 0.2  $\mu\text{m}$  nitrocellulose, 0.2  $\mu\text{m}$  PVDF, or 0.45  $\mu\text{m}$  low fluorescent PVDF

Pad materials and buffer: proprietary

Gel tray: two reusable trays to wet and equilibrate membrane and pads

# Table of Contents

<b>Chapter 1</b>	<b>Introduction</b> .....	1
	1.1 Unpacking and Setup Instructions.....	2
	1.2 Chemical Compatibility.....	2
	1.3 Safety/Cautions/Warning .....	3
	1.4 Warranty.....	4
<b>Chapter 2</b>	<b>Equipment and Reagents Overview</b> .....	5
	2.1 User Interface.....	6
<b>Chapter 3</b>	<b>Using the Trans-Blot Turbo Transfer System</b> .....	9
	3.1 Transfer Using Transfer Packs .....	9
	3.1.1 Mini Transfer Pack (Single Mini Gel) Setup.....	10
	3.1.2 Midi Transfer Pack (Single Midi Gel or Two Mini Gels) Setup .....	10
	3.2 Placing a Transfer Pack into the Cassette .....	12
	3.3 Setting Up Transfer Using RTA Transfer Kits .....	14
	3.4 Transfer Protocols .....	15
	3.4.1 Transfer Using Preprogrammed Protocols .....	16
	3.4.2 Transfer Using the Turbo Protocol .....	16
	3.4.3 Preprogrammed Protocols .....	17
	3.4.4 User-Defined Protocols.....	18
	3.4.5 Disassembly and Removal of the Membrane .....	18
	3.5 Setting Up a New Protocol.....	19
	3.6 Transfer Using Traditional Semi-Dry Consumables.....	20
	3.7 Optimizing Transfer Conditions.....	21
<b>Appendices</b>	<b>Appendix A. Maintenance</b> .....	23
	<b>Appendix B. Troubleshooting</b> .....	24
	<b>Overview of the Three Protocol Modes</b> .....	26
	<b>Consumables and Related Products</b> .....	29





# 1 Introduction



Fig. 1. Trans-Blot Turbo Blotting System.

Semi-dry western blotting is a common technique in many research and diagnostic laboratories. Conventional semi-dry blotting protocols are often cumbersome, requiring a great deal of time-consuming reagent preparation and setup, followed by an electrophoretic transfer that could take up to an hour or more. Bio-Rad's Trans-Blot Turbo System accelerates the semi-dry blotting process without sacrificing performance. With the Trans-Blot Turbo System, transfer time is reduced to as little as 3 min, and the prepackaged transfer packs provide excellent transfer efficiency and reproducibility while eliminating the time and mess associated with traditional transfer methods.

The Trans-Blot Turbo System consists of the main instrument with two blotting cassettes and single-use prepackaged transfer packs that contain buffer-saturated membranes and ion reservoir stacks.

Each blotting cassette has a built-in pair of anode and cathode electrode plates and can accommodate one or two mini format (7.0 x 8.5 cm) gels or a single midi format (8.5 x 13.5 cm) gel. Closed cassettes lock to hold a gel in contact with a transfer membrane placed between two ion reservoir stacks. The loaded cassettes are simply inserted into the instrument to access the power supply for protein transfer. A preprogrammed user-defined

transfer protocol is easily selected from the firmware menus using the navigation and selection buttons and the alphanumeric keypad. During the run, transfer conditions and run progress are displayed on the LCD screen.

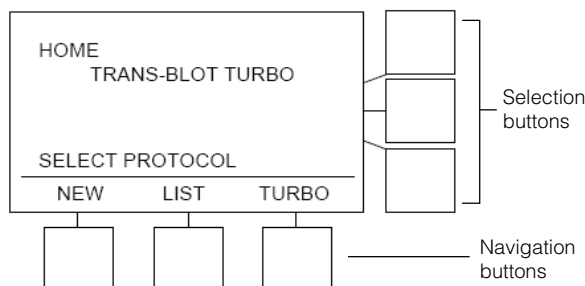

Fig. 2. Home screen of the Trans-Blot Turbo System.

The buffer-saturated ion reservoir stacks and membrane are available as ready-to-use prepackaged, disposable, single-use Trans-Blot Turbo Transfer Packs in two sizes, for transfer of single mini gels (7.0 x 8.5 cm) and a larger size (8.5 x 13.5 cm) for transfer of midi gels or simultaneous transfer of two mini gels (7.0 x 8.5 cm). Both the mini and midi transfer packs are available with either nitrocellulose or PVDF membranes. These prepackaged transfer packs allow for efficient transfer in as little as 3 min. Gels can be transferred immediately after electrophoresis without equilibration. The reagents and consumables available in the transfer packs are also available in ready-to-assemble format, as part of the Trans-Blot Turbo RTA Transfer Kits. The system will also accommodate traditional semi-dry western blotting consumables such as filter paper and Towbin buffer with efficient transfer in 30–60 min.

Selection of transfer protocols using the navigation and selection buttons is simple and the system is designed to handle multiple sequential runs with no intervals of delay except for the reloading of the cassettes.

## 1.1 Unpacking and Setup Instructions

The Trans-Blot Turbo Starter Kits include the main unit, two cassettes (bases and lids), blot roller, standard power cord, quick start guide, instruction manual, and your choice of nitrocellulose or PVDF membranes in mini or midi sizes.

Place the system on a level surface with at least 6 cm of clearance in the back for proper ventilation. Plug the power cord into the back of the instrument, and then connect it to a standard grounded outlet. Remove the foam ring separating the instrument and cassettes. Power on the instrument using the switch on the right side of the unit.

**Note:** Do not place heavy items on the top of the Trans-Blot Turbo System.

## 1.2 Chemical Compatibility

The Trans-Blot Turbo System and cassette components are not compatible with strong acids or bases, chlorinated hydrocarbons (for example, chloroform), aromatic hydrocarbons (for example, toluene, benzene), or acetone. The cassettes and instrument casing can be cleaned with water and a mild detergent, but do not use abrasives or organic solvents. The stainless steel cathode electrode, which is housed in the cassette lid, can be cleaned with 7% acetic acid and wiped down with water.

### 1.3 Safety/Cautions/Warning

The following guidelines should be observed and followed when using the Trans-Blot Turbo instrument.

The Trans-Blot Turbo instrument has been tested for operation at 15–31°C ambient temperature and 0–95% relative humidity (noncondensing). Operating the unit outside these conditions is not recommended.

- To ensure adequate cooling, be sure that there is at least 6 cm of clearance behind the unit and that the fan vent at the rear of the unit is not blocked
- Always connect the unit to a grounded AC outlet using the power cord provided
- Use caution when removing a cassette from the unit after a transfer run. The cassette may be warm to the touch
- Do not operate in extreme humidity (>95%) or where condensation can affect the internal electrical circuits of the unit
- Operation of the Trans-Blot Turbo System at temperatures <15°C is not recommended. However, the unit can function in a cold environment and can be operated immediately. When returning the unit to normal conditions, allow it to equilibrate to room temperature before use
- For your safety and for the protection of your Trans-Blot Turbo instrument, Bio-Rad suggests you routinely clean the instrument in accordance with the enclosed instructions and that you routinely check the contact pins located at the back of the instrument cavity, as outlined in Appendix A
- Bio-Rad recommends that you rinse and dry each cassette, base, and lid in deionized water to remove residual salts and to prevent salt buildup. Air-dry or use a paper towel to dry the cassette
- Do not add excess or additional buffer into the transfer cassette at any point prior to running the instrument
- Install and operate the Trans-Blot Turbo Transfer System in a clean and dry location away from excess moisture. During operation, avoid using excessive buffer in or around the instrument.

**Important: This instrument is intended for laboratory use only.**

This product conforms to the class A standards for electromagnetic emissions intended for laboratory equipment applications. It is possible that emissions from this product may interfere with some sensitive appliances when placed nearby or on the same circuit as those appliances. The user should be aware of this potential and take appropriate measures to avoid interference. This product is designed and certified to meet EN 61010\* safety standards. Certified products are safe to use when operated in accordance with the instruction manual. This safety certification does not extend to accessories that are not EN 61010 certified, even when used with this unit.

This instrument should not be modified or altered in any way. Alteration of this instrument will void the manufacturer's warranty, void the EN 61010 certification, and create a potential safety

hazard for the user. Bio-Rad is not responsible for any injury or damage caused by the use of this instrument for purposes other than those for which it is intended, or by modifications of the instrument not performed by Bio-Rad or an authorized agent.

\* EN 61010 is an internationally accepted electrical safety standard for laboratory instruments.

## **1.4 Warranty**

The Trans-Blot Turbo Transfer System and associated accessories are covered by a standard Bio-Rad Laboratories warranty. Contact your local Bio-Rad Laboratories representative for the details of the warranty.

## 2 Equipment and Reagents Overview

The Trans-Blot Turbo instrument and reagents are designed to provide fast, efficient, and reproducible western blots of protein gels in as little as 3 min. Each convenient transfer pack contains the necessary materials to efficiently transfer a single mini gel (7.0 x 8.5 cm) or one midi or two mini gels (8.5 x 13.5 cm). The transfer packs contain two buffer-soaked ion reservoir stacks along with either a prewetted nitrocellulose or PVDF membrane. The membranes do not require any pretreatment before use.

The reagents and consumables available in the transfer packs are also available in a ready-to-assemble format as part of the Trans-Blot Turbo RTA Transfer Kits. These kits provide the same optimized buffers and consumables as the transfer packs, but require wetting of the membranes and filters before use.

**Note:** Traditional semi-dry western blotting consumables can also be used with the system. See section 3.7.



Fig. 3. Trans-Blot Turbo instrument.



**Fig. 4. Cassette base and lid.** Reversible lid is labeled with lock, unlock, and safety hazard symbols.

For transfer, a gel is sandwiched between two ion reservoir stacks in the cassette. Each cassette can hold one or two mini format gels (7.0 x 8.5 cm) or one midi format gel (8.5 x 13.5 cm). One or both cassettes can be used for a blotting run. If both cassettes are run, they must use the same protocol and have the appropriate combinations of gels, as shown in Table 1.

The cassettes can be run individually or simultaneously with independent start times using the same protocol. This allows the user to perform multiple sequential runs without interruption, except for reloading a cassette. At the end of each cassette run, the ion reservoir stacks are discarded. Membranes and gel (if needed) can be used immediately for downstream applications or stored for later use.

The cassette bays are labeled A and B for convenience, and the cassettes are freely interchangeable between the bays. There is no preference as to which bay contains which cassette when running the combination of one midi and two mini gels. Also, one bay (either A or B) can remain empty during a run.

**Table 1. Acceptable gel transfer combinations when both bays are in use.**

	Acceptable Gel Combinations		Unacceptable Gel Combinations	
	1	2	1	2
<b>Upper bay A</b>	1 mini format gel	2 mini or 1 midi format gels	1 mini format gel	2 mini or 1 midi format gels
<b>Lower bay B</b>	1 mini format gel	2 mini or 1 midi format gels	2 mini or 1 midi format gels	1 mini format gel

## 2.1 User Interface

The user interface consists of an LCD menu screen on the front of the system. Three buttons below the screen are used to navigate among menu screens. Three buttons to the right of the screen are for user selections. A standard alphanumeric keypad is used for input of text and numbers.

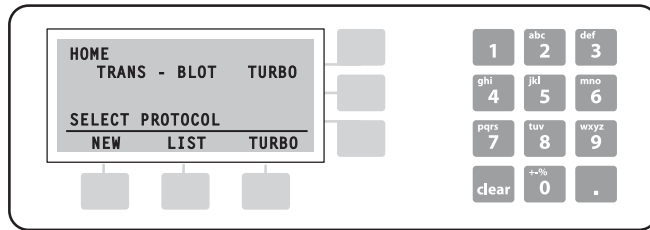

Fig. 5. Trans-Blot Turbo System user interface.

From the Home menu, three modes are available:

- NEW mode. Create, run, and save a new protocol for your protein of interest
- LIST mode. Select from either a list of Bio-Rad preprogrammed protocols optimized for a variety of protein and gel types or a list of user-defined protocols
- TURBO mode. Quick access menu for transfers of mixed MW proteins (MW 5–150 kD). Designed for efficient transfer of a wide variety of proteins over a broad range of molecular weights





# 3 Using the Trans-Blot Turbo Transfer System

The Turbo protocol, when combined with Trans-Blot Transfer Packs, provides highly efficient transfer for a wide variety of proteins. However, run conditions may need to be adjusted for a particular protein of interest. Protocols optimized for different protein and gel types are available in the Bio-Rad preprogrammed protocols in LIST mode.

The system may also be used with Trans-Blot Turbo RTA Transfer Kits, which offer the same transfer speed and efficiency as the transfer packs, or superior performance to traditional semi-dry blotting consumables such as extra-thick filter paper and Towbin transfer buffer (speed and efficiency will be similar to standard semi-dry blotting techniques). Please refer to the Bio-Rad Protein Blotting Guide, bulletin 2895, for more information on the methods of electrophoretic transfer. The Protein Blotting Guide can be downloaded as a PDF from [bio-rad.com](http://bio-rad.com), or call your local Technical Support number listed at the end of this document and request bulletin 2895.

## 3.1 Transfer Using Transfer Packs

Recommendations:

- Wear gloves at all times during the blotting process to prevent contamination of the gels or membranes
- Transfer gels immediately after electrophoresis without an equilibration step
- The transfer membranes and stacks of the transfer packs are prewetted and do not require any further pretreatment. Open the transfer packs immediately before use to avoid drying the membrane
- Use only the appropriate combinations of gels, as shown in Table 1
- If you need to move the membrane, carefully use flat tweezers or forceps

Select the appropriate transfer pack for your application according to Table 2. These packs are stable for several months at room temperature. However, to extend their shelf life, store

them at 4°C. The transfer membranes and stacks of the transfer packs are prewetted and do not require any further pretreatment (for example, wetting of the PVDF membrane).

**Table 2. Transfer pack options.**

Gel Size, cm	0.2 $\mu$ m Nitrocellulose Membrane, catalog number	0.2 $\mu$ m PVDF Membrane, catalog number
For one mini format gel, 7.0 x 8.5	1704158	1704156
For one midi format gel or two mini format gels, 8.5 x 13.5	1704159	1704157

### 3.1.1 Mini Transfer Pack (Single Mini Gel) Setup

The packaging for the mini transfer pack has the two ion reservoir stacks in the left and right wells of the tray. The right well contains the stack for the anode (below the gel) and is layered with the transfer membrane (nitrocellulose or PVDF). The left well contains the stack for the cathode (above the gel) (Figure 6). Use the finger wells of the tray to access the stacks and easily lift them from the tray. The text above each finger well signifies the stack location in the cassette. The stack and membrane in the right finger well, labeled Bottom (+) is placed on the anode in the cassette base. The stack in the left finger well, labeled Top (-) is placed on top of the transfer gel, closest to the cathode.

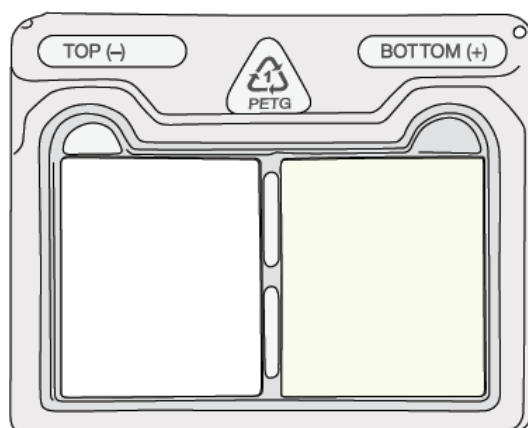

Fig. 6. The anode stack with the membrane is on the right, while the cathode stack is on the left.

### 3.1.2 Midi Transfer Pack (Single Midi Gel or Two Mini Gels) Setup

The packaging for the midi transfer pack has a tray containing the two ion reservoir stacks placed on top of each other in the tray. The ion reservoir stack on the top has a tab on the right side and is for the anode (below the gel). This stack is layered with the transfer membrane. The ion reservoir stack for the cathode (above the gel) is located below the membrane and anode stack and has a tab on the left side (Figure 7). Use the finger wells and tabs to access the appropriate stack and lift it from the tray. As with the mini trays, the text above the finger wells signifies the stack location in the cassette. The top stack and membrane, with the tab on the right, is labeled Bottom (+) and is placed on the anode in the cassette base. The stack below the anode stack, with the tab on the left, is labeled Top (-) and is placed on top of the transfer gel, closest to the cathode. For transferring two mini

gels simultaneously, arrange the gels so that the foot of the gels (low molecular weight side) face each other on the membrane. The gels will have to be placed longitudinally on the stack (Figure 12).

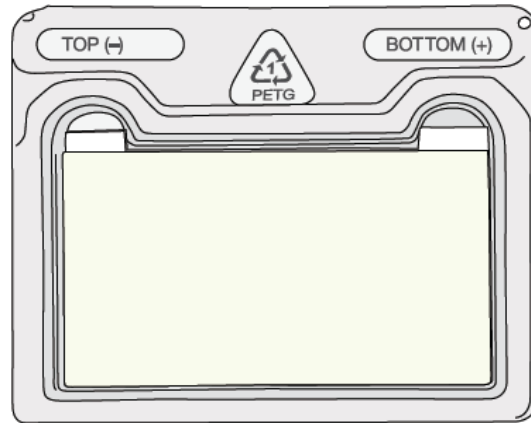

Fig. 7. The anode stack with the membrane is on the top while the cathode stack lies beneath the anode stack and membrane.

The transfer packs are vacuum sealed. Check that the membrane does not lift away with the foil packaging lid. If necessary, hold the edge of the membrane and peel while opening the pack.

**Note:** The base of the tray is PETG plastic and can be recycled according to local regulations for class 1 plastics.

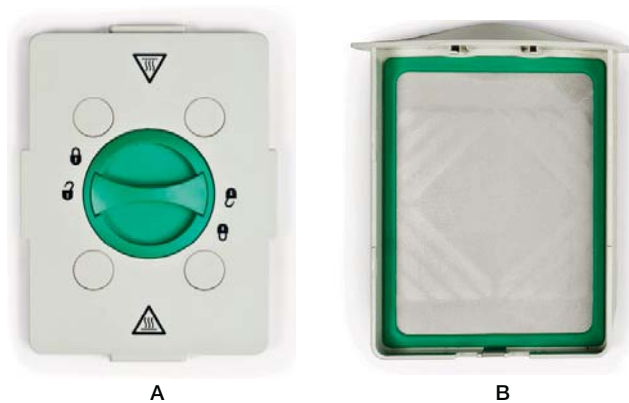

Fig. 8. Open cassette. A, lid with cathode (-) on the underside; B, base with anode (+).

### 3.2 Placing a Transfer Pack into the Cassette

See Figures 10 and 11 for step-by-step instructions on placing a transfer pack into a cassette.

- The membranes and stacks are designed to be lifted from the tray and placed in the cassette. Do not invert the stacks when removing them from the tray
- The assembled transfer packs should be reasonably centered and flat within the base of the cassette (anode)
- We do not recommend moving the stacks once they are placed, as this may introduce air between the layers. If the stack must be moved after placement, use a blot roller to expel any trapped air bubbles
- Each stack uses multiple layers of material for maximum transfer efficiency. Removing stack layers is not advised
- Refrain from adding any extra transfer buffer to the cassette, as saturated transfer stacks provide ample transfer buffer.

Figure 9 shows the proper final assembly of the blotting sandwich in the cassette and is applicable to all transfer packs.

- If the gel and ion reservoir stacks are layered out of order during assembly of the blotting sandwich, carefully disassemble the components so as not to damage the membrane. Reassemble the stack and use the blot roller to remove air bubbles between the components

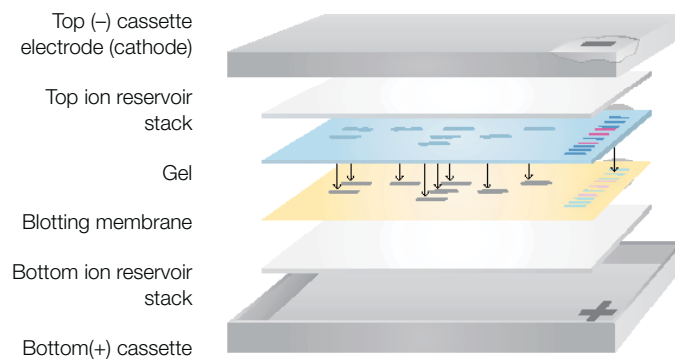
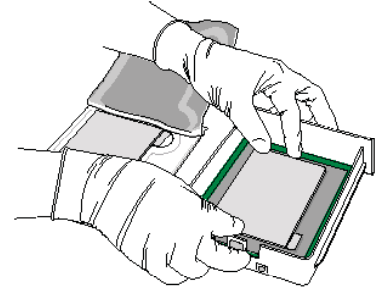
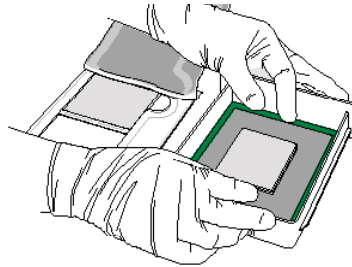

Fig. 9. Proper layering of the assembled transfer pack.

**Mini Transfer Pack  
(for one mini format gel)**

**Midi Transfer Pack  
(for one midi format gel or  
two mini format gels)**

Lay the ion reservoir stack with the membrane (anode stack) in the center of the cassette base. Ensure that the stack is not overlapping the green rubber molding in the base.



Carefully align the gel on the membrane. If necessary, gently use the blot roller to remove air bubbles between the gel and membrane. If transferring two mini gels, place them on the membrane so that the feet of the gels are facing toward each other.

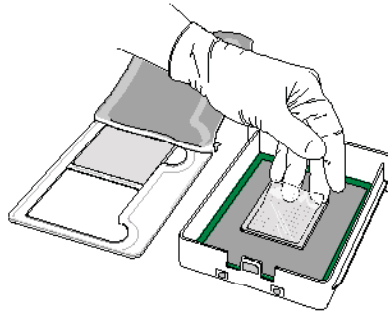

Gently place the second ion reservoir stack (cathode stack) on the gel.

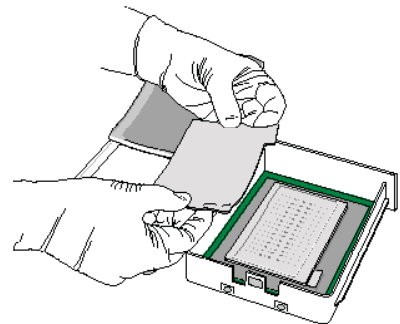
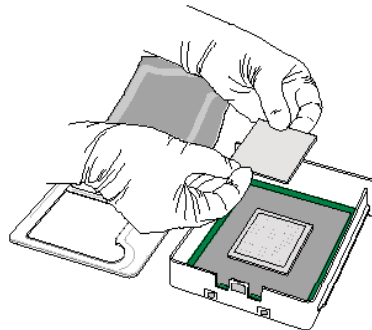

Use the blot roller to remove any air bubbles in the assembled transfer pack and provide consistent contact between the layers.

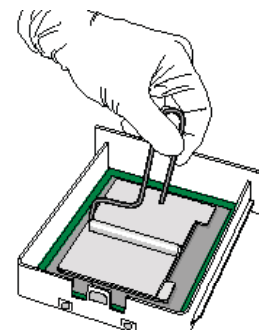
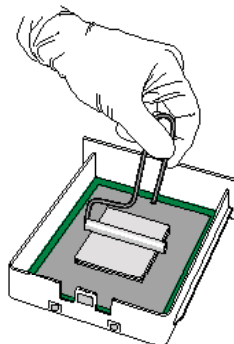

**Fig. 10.** Assembling the mini format transfer pack.

**Fig. 11.** Assembling the midi format transfer pack.

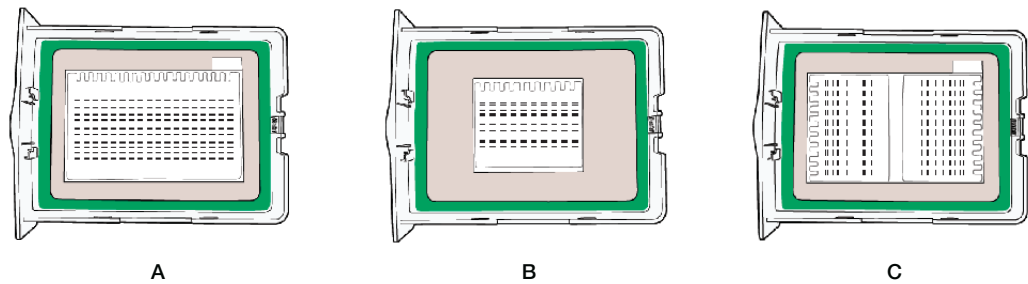

**Fig. 12. Suggested placement of assembled transfer stacks in a cassette.** **A**, midi stack and gel placement; **B**, mini stack and gel placement; **C**, two mini gels on a midi stack.

Set the transfer stack close to the center of the cassette. A midi stack only fits along the long axis of the cassette. It is not necessary to move an assembled transfer pack if it is only slightly off center in the cassette.

Once the stacks are positioned in the cassette base, place the cassette lid on the base. The lid is reversible, but ensure that the electrical contacts fit closely into the slots in the base. Press the lid down firmly and turn the dial clockwise to engage the lid pins into the locking slots.

Slide the cassette (with the dial facing up) into one of the Trans-Blot Turbo instrument bays until it makes contact with the magnetic interlock in the back of the instrument tub and you hear a click. The cassette can be inserted into the bays with or without power to the system.

The bays are labeled A (top) and B (bottom), and cassettes can be inserted interchangeably into the bays. There is no requirement for both cassettes to be inserted; one bay (either A or B) can be left empty when a protocol is run.

The instrument is now ready to begin a transfer protocol. Refer to the following sections for details on transfer using preprogrammed and user-defined protocols.

**Note:** A transfer for one cassette can be started while you are assembling a second cassette. The second transfer can be started independently as long as the same protocol is being used for both.

### 3.3 Setting Up Transfer Using RTA Transfer Kits

Trans-Blot Turbo RTA Transfer Kits provide the same reagents and consumables available in the transfer packs, but in a ready-to-assemble format. The protocol for using them is similar to that used for the transfer packs, except membranes and transfer stacks must be soaked in Trans-Blot Turbo Transfer Buffer before use. Do not equilibrate the gel before transfer.

1. Prepare the Trans-Blot Turbo Transfer Buffer according to instructions on the bottle.
2. Wet and equilibrate the membrane and transfer stacks:
  - Nitrocellulose membrane — immerse in 30 ml of 1x transfer buffer and equilibrate for 2–3 min
  - PVDF and LF PVDF membranes — immerse in 100% methanol or ethanol (use reagent grade ~85% or molecular biology grade ~95–98% purity) until the membrane

is translucent. Transfer to a soaking tray containing 30 ml of 1x transfer buffer, ensure the membrane is submerged, and equilibrate 2–3 min

- Transfer stacks
    - Midi stacks — immerse two stacks separated by blue sheets in two soaking trays, each containing 50–70 ml of transfer buffer for 2–3 min
    - Mini stacks — immerse two stacks separated by blue sheets side-by-side in a soaking tray containing 50–70 ml of transfer buffer for 2–3 min
3. Follow the procedure described in Figures 9–10 above for assembling the transfer sandwiches in transfer cassettes, followed by an additional step: once assembled, remove excess transfer buffer by inverting the cassette base, with the assembled stack carefully held in place, into a waste container. Once the excess buffer is removed, place the cassette lid on the base and proceed with the transfer step (section 3.4).

### 3.4 Transfer Protocols

1. Turn on the Trans-Blot Turbo System using the switch located on the right side of the instrument. After an initial Boot screen, the system will proceed to the Home screen.
2. On the Home screen you can use the navigation buttons to choose your protocol:
  - New — set up a new protocol (see section 3.5)
  - List — select a preprogrammed protocol (see section 3.4.1)
  - Turbo — select Turbo program (see section 3.4.2)
3. After selecting your protocol press the navigation button that corresponds to A:RUN for the cassette in the upper bay or B:RUN for the cassette in the lower bay (Figure 13). A beep will sound to signal the start of the transfer for the chosen cassette. If you are running both cassettes, press the button to begin one transfer (either A:RUN or B:RUN), and then press the other button at any time during the run to immediately start the second cassette. **Both cassettes must use the same protocol.**

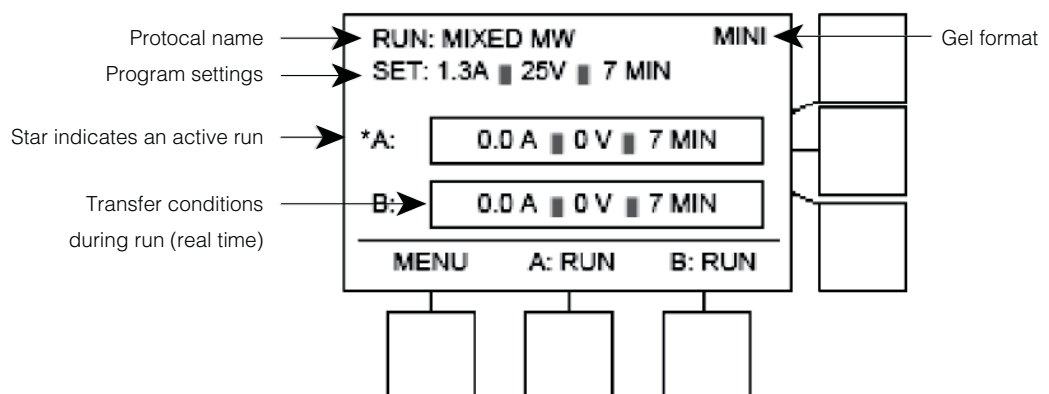

Fig. 13. Transfer Turbo Run screen.

- The protocol will run automatically. The screen will display the conditions of the transfer and the progress of the run.

**Note:** A run can be paused by pressing the corresponding A: STOP or B: STOP navigation button during the run. The user has a choice to continue from the time point of the pause, restart the run from the beginning, or terminate the run (Figure 14.)

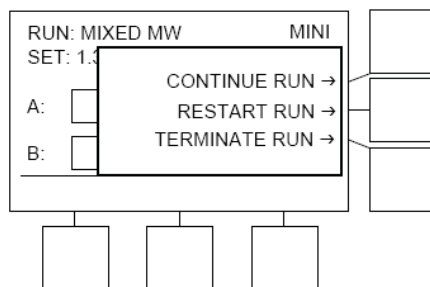

Fig. 14. Trans-Blot Turbo System Terminate Run screen.

When the transfer protocol is complete, the screen will display RUN COMPLETE, and an alarm will be heard (Figure 15). Skip to section 3.4.5, Disassembly and Removal of Membrane.

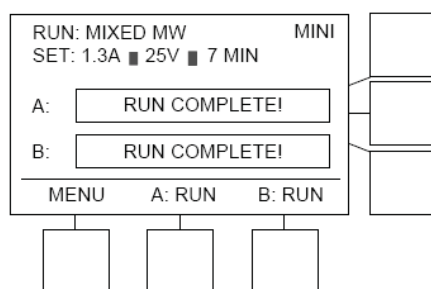

Fig. 15. Trans-Blot Turbo Run Complete screen.

### 3.4.1 Transfer Using Preprogrammed Protocols

All steps are identical to those in section 3.4 except for step 2, which is described here.

On the Home screen press the navigation button that corresponds with LIST (Figure 12) to choose between the Bio-Rad preprogrammed protocols and user-defined protocol lists (Figure 17).

### 3.4.2 Transfer Using the Turbo Protocol

The Turbo button immediately accesses the MIXED MW program. It is designed for efficient transfer of a wide variety of proteins over a broad range of molecular weights. The same parameters can be also accessed in the Bio-Rad preprogrammed protocols under LIST > BIO-RAD > MIXED MW.

- Turn on the Trans-Blot Turbo System using the switch located on the right side of the instrument. After an initial Boot screen, the system will proceed to the Home screen.



2. On the Home screen you can use the navigation buttons to choose your protocol.
3. After selecting Turbo, there will be a selection screen for the number, size, and type of gel to be transferred. Use the corresponding selection button to choose the option for the combination of gels in the run. The option varies the current for the run (1.3 A for a single mini format gel, 2.5 A for a single midi or two mini format gels). Mini-PROTEAN TGX Gels can be transferred using the “1 Mini Gel” protocol or the “1 Mini-PROTEAN TGX” protocol, which transfers a single Mini-PROTEAN TGX Gel in 3 min.

Follow steps 3 and 4 from section 3.4.

### 3.4.3 Preprogrammed Protocols

Pressing the Bio-Rad preprogrammed protocols button accesses the protocols described in Table 3.

- **STANDARD SD** provides typical semi-dry transfer conditions for use with conventional semi-dry western blotting consumables (see section 3.7)
- **1.5 mm GEL** uses a longer transfer time (10 min) for more efficient transfer when using 1.5 mm thick gels
- **HIGH MW** is optimized for more efficient transfer of large proteins (>150 kD)
- **LOW MW** is optimized for more efficient transfer of small proteins (<30 kD)
- **MIXED MW** is for efficient transfer of proteins over a broad range of molecular weights (5–150 kD). This protocol is also accessed via the Turbo navigation button
- **1 Mini-TGX** is an ultrafast protocol that will transfer a single Mini-PROTEAN TGX Gel with mixed MW proteins (5–150 kD) in 3 min with excellent efficiency

**Table 3. Bio-Rad preprogrammed protocols.**

Protocol Name	MW, kD	Time, min	2 Mini Format Gels or 1 Midi Format Gel (per cassette)		1 Mini Format Gel (per cassette)
Standard SD	Any	30	Up to 1.0 A; 25 V		
1.5 mm GEL	Any	10	2.5 A, up to 25 V		1.3 A, up to 25 V
High MW	>150	10			
Low MW	<30	5			
Mixed MW (Turbo)	5–150	7			
1 Mini-TGX	5–150	3	–		2.5 A, up to 25 V

### 3.4.4 User-Defined Protocols

Selecting USER-DEFINED protocols accesses the protocols that have been previously saved by users (Figure 16). Use the top and bottom selection buttons to scroll to the appropriate choice. Push RUN to go to the system run screen where a transfer can be started.

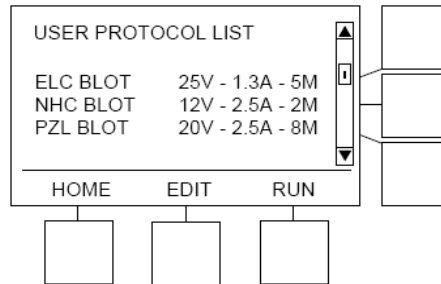

Fig. 16. User protocols screen.

### 3.4.5 Disassembly and Removal of the Membrane

**Note:** Use caution when removing a cassette from the unit after a transfer run. The cassette may be warm.

1. Remove the cassette from the bay by pulling it straight out of the instrument. The LCD menu screen will automatically return to the protocol screen that has just been completed. The system is ready for another run. If a different protocol or combination of gels will be blotted in the next run, refer to Table 1 for the appropriate combinations of gels that can be used in a single run, and proceed to the Home menu to select the correct protocol.
2. Unlock the cassette by turning the dial counterclockwise to the Unlock position.
3. Disassemble the blotting sandwich and place the membrane in a suitable container. If you are using a PVDF membrane, place it immediately into a storage solution (for example, deionized water or blocking or staining solution) as the membrane will quickly dry out. If a PVDF membrane requires rewetting, dip it in methanol or ethanol until uniformly opaque, then wash with deionized water.
4. Discard the ion reservoir stacks after one use; do not attempt to reuse them.
5. Empty residual liquid from the cassette. If no additional transfer will be performed immediately, rinse the base and lid of the cassette with deionized water and dry them with a paper towel.

6. Turn off the Trans-Blot Turbo System with the power switch if it is no longer required.

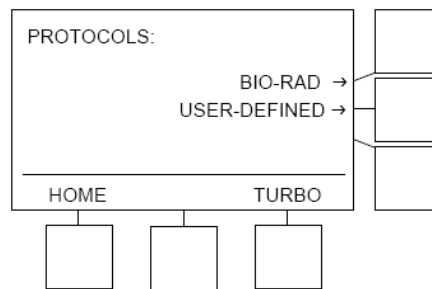

Fig. 17. Protocol options.

### 3.5 Setting Up a New Protocol

Assembly of the blotting sandwich is described in sections 3.1 and 3.2. This section describes setting up a new protocol.

On the Home screen (Figure 12), press the navigation button that corresponds with NEW.

Pressing NEW will bring up the Edit screen (Figure 18), where the user can set the three parameters of current (maximum 2.5 A), voltage (maximum 25 V), and time (maximum 90 min) using the alphanumeric keypad. The user can toggle between setting a constant voltage (CONST V) or a constant current (CONST A) using a navigation button. After the settings have been determined, a prompt will appear to name and save the protocol for subsequent use, if desired. A saved protocol can later be accessed under LIST > USER-DEFINED protocols. Saved protocols can be deleted when no longer required.

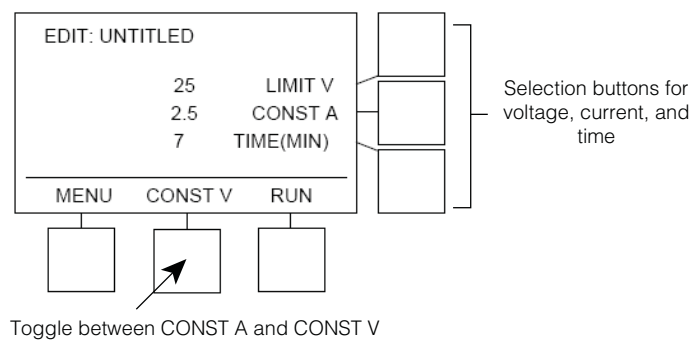

Fig. 18. Edit NEW protocol screen.

To prevent damage to the cassette or instrument, the Trans-Blot Turbo System will terminate a transfer if 30 watts per hour is exceeded over the course of the run. Depending on the initial run conditions when designing a protocol, the system may display a message warning that the 30 watts/hour limit may be exceeded during the run.

### 3.6 Transfer Using Traditional Semi-Dry Consumables

Typical procedure utilizing the Trans-Blot Turbo System and conventional semi-dry western blotting consumables is detailed below:

1. Equilibrate the gel in Towbin transfer buffer (25 mM Tris, 192 mM glycine pH 8.3, 20% MeOH) for 10 min.
2. Soak two pieces of extra-thick (2.4 mm) filter paper in transfer buffer. Six pieces of thick (0.8 mm) filter paper can be used if extra-thick paper is not available.
3. While the gel is equilibrating, prepare a transfer membrane. Wet a nitrocellulose membrane briefly in transfer buffer or PVDF membrane in methanol or ethanol for 30 sec, then wash in water for 1–2 min, and equilibrate in transfer buffer for at least 10 min with agitation.
4. Assemble the transfer sandwich on the cassette base (anode) by placing one piece of wet extra-thick or three pieces of wet thick filter paper on the bottom, then the membrane, the gel, and finally, the remainder of the wet filter paper on top. Use the blot roller to remove air from between the assembled layers (Figure 19).
5. Once the stacks are positioned in the cassette base, place the cassette lid on the base. The lid is reversible, but ensure that the electrical contacts fit closely into the slots in the base. Press the lid down firmly and turn the dial clockwise to engage the lid pins into the locking slots.
6. Load a second cassette if desired. Refer to Table 1 for the appropriate combinations of gels that can be used in a single run.
7. Slide the cassette (with the dial facing up) into the bay until it makes contact with the magnetic interlock and you hear a click. Cassettes can be inserted into the bays in any order, with or without power to the system.
8. Select the LIST button from the Home menu and the STANDARD SD transfer protocol from the Bio-Rad preprogrammed protocols, or the user-defined protocol of choice.
9. To initiate the run, press the navigation button that corresponds to A:RUN for the cassette in the upper bay or B:RUN for the cassette in the lower bay.

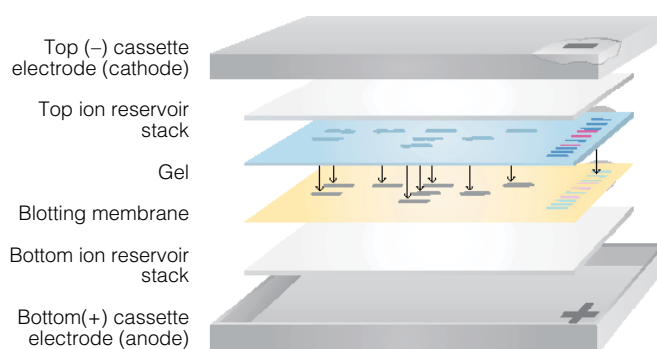

Fig. 19. Proper assembly of blotting sandwich using traditional consumables.

For further information, refer to the Bio-Rad Protein Blotting Guide, bulletin 2895, for detailed information. Bulletin 2895 can be downloaded as a PDF from [bio-rad.com](http://bio-rad.com), or call your local Technical Support number listed at the end of this document.

### 3.7 Optimizing Transfer Conditions

The following techniques, alone or in combination, will increase transfer efficiency:

- Use a low-percentage gel or a gradient gel. High-percentage gels retard protein transfer, especially with large proteins
- High molecular weight proteins may require increased transfer times, particularly when using thick gels. Increase the transfer time or power conditions
- With long transfer times or high power conditions, some very low molecular weight proteins may transfer through the membrane to the lower ion reservoir stack. Use a shorter transfer time or reduce power conditions for the most efficient transfers
- Use the blot roller to remove any air bubbles when assembling the transfer sandwich. Air bubbles between layers of the assembled sandwich will prevent protein transfer, producing blank spots on the membrane.

**Table 4. Recommended power conditions for transfer using the Trans-Blot Turbo System.**

	Single Mini Gel	Two Mini Gels or One Midi Gel
With Turbo Transfer Packs	25 V, 1.3 A, 7 min	25 V, 2.5 A, 7 min
With Standard Semi Dry Components	25 V, 1.0 A, 30 min	

Refer to the Bio-Rad Protein Blotting Guide, bulletin 2895, for more information on optimizing electrophoretic transfer. The Protein Blotting Guide can be downloaded as a PDF from [bio-rad.com](http://bio-rad.com), or call your local Technical Support number listed at the end of this document.



# 4 Appendices

## Appendix A. Maintenance

The Trans-Blot Turbo System requires little maintenance. After you finish using the Trans-Blot Turbo System, rinse each cassette, base, and lid in deionized water to remove residual salts and to prevent salt buildup. Air-dry or use a paper towel to dry the cassette.

For each transfer cassette there are four connection contacts located at the back of the instrument base cavity (Figure 20). Over time it is possible that buffer or other contaminants have been exposed to these contacts causing them to stick in the depressed position. With the unit unplugged, use isopropyl alcohol and a cotton swab or isopropyl wipes to clean these contacts. Push on each contact to ensure that it depresses freely. The contacts should be checked and cleaned monthly as part of standard equipment maintenance procedures.

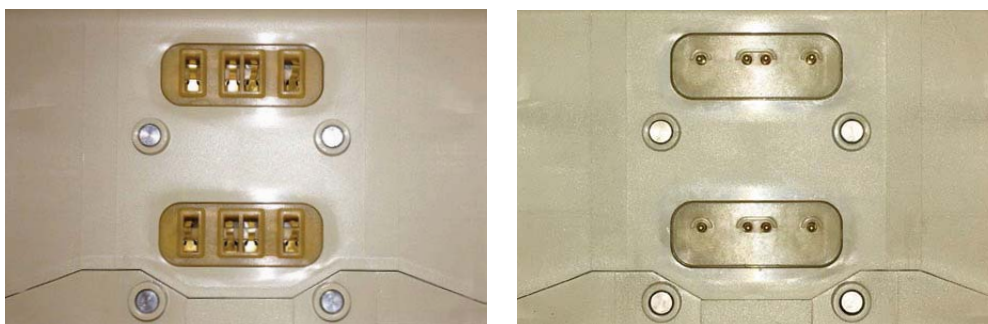

**Fig. 20. Connection contacts inside the instrument base cavity.** Your instrument will have either leaf spring contacts (left) or pogo pin contacts (right).

Clean any accidental buffer spills in the instrument bays with a dry towel.

The cassettes and instrument casing can be cleaned with water and mild detergent; do not use abrasives or organic solvents.

Periodically unplug the instrument and wipe the instrument casing with a moist cloth or paper towel. Ensure that the electrode contacts in the bays are clean. Electrode plates should be occasionally cleaned with deionized water or a mild detergent to reduce salt buildup. If the cathode plate has excessive salt buildup, 7% acetic acid can be used to remove the residue.

Occasionally check that the cooling fan vent is free of debris and dust.

Clean and inspect the instrument and cassette after each use for damage. Contact Bio-Rad technical support if any damage is noted.

## Appendix B. Troubleshooting

For more information on troubleshooting, see the Bio-Rad Protein Blotting Guide, bulletin 2895, which can be downloaded as a PDF from [bio-rad.com](http://bio-rad.com), or call your local Technical Support number listed at the end of this document.

Symptom/Problem	Suggested Corrections
Poor or no electrophoretic transfer; excessive protein remains in the gel (as detected by staining the gel after transfer)	<p>Transfer time may be too short. High molecular weight proteins (&gt;150 kD) may require increased transfer time.</p> <p>Change the percentages of the components for handcast gels. The Bio-Rad Protein Blotting Guide, bulletin 2895, has extensive information on casting acrylamide gels.</p> <p>The wrong protocol relative to the gel combination may have been used for the transfer. Refer to Table 1 for acceptable combinations of gels that can be used in a single run.</p> <p>There may be an excessive amount of protein loaded on the gel. Reduce the amount of protein on the gel.</p> <p>While the preprogrammed protocols efficiently transfer most proteins, some proteins may require further optimization. Increase the transfer time in 1 min increments. Change voltage and current if required.</p>
Poor or no electrophoretic transfer; little or no protein remains in the gel (as detected by staining the gel after transfer)	<p>The blotting sandwich may be assembled in the wrong order. See Figure 9 for the correct assembly.</p> <p>The detection system may not be working or may not be sensitive enough. Include proper antigen controls to test detection kit sensitivity or use a total protein stain or stain-free technology to detect protein transfer to the membrane prior to immunodetection.</p>
Blot sandwich exceeds 70°C after transfer	<p>An incorrect program for the gel combination was used. Refer to Table 1 for the acceptable combinations of gels that can be used in a single run.</p> <p>Reduce run current, voltage, or time.</p>
Cassette does not stay in place in the instrument bay	<p>Make sure that the dial of the cassette lid is in the Lock position and the lid pins are engaged. The dial should be facing up when the cassette is inserted into the bay.</p> <p>The magnetic interlock may be damaged or have failed. Contact Technical Support for assistance.</p>
POWER FAILURE! PRESS ANY KEY TO CONTINUE is displayed on the screen	<p>Power to the instrument was interrupted during a run and the run was aborted. It will need to be restarted. Shut off the power switch, correct the power outage, and restart the instrument.</p>



---

Swirls or missing bands; diffuse transfers	<p>There may be poor contact between the membrane and the gel. Air bubbles (or excess buffer when using traditional semi-dry consumables) remain between the membrane and gel. Use the blot roller to ensure that air bubbles or excess buffer are removed.</p> <p>There may be poor contact between the assembled sandwich and the electrodes (when conventional semi-dry consumables are used). Use extra-thick filter paper or add additional sheets of thick buffer-wetted filter paper to improve contact.</p> <p>The membrane may have dried. White spots on a nitrocellulose or PVDF membrane indicate dry areas where protein will not bind.</p> <p>Power conditions may be too high for your particular gel. Adjust voltage and current conditions.</p> <p>The gel electrophoresis may be at fault. Artifacts of electrophoresis may be produced by poor polymerization, inappropriate running conditions, contaminated buffers, sample overload, etc. Consult your electrophoresis manual for more details.</p> <p>When using a single mini transfer pack, the assembled transfer pack may have been placed at the extreme edge of the cassette bottom. Ensure that assembled transfer packs are placed near the center of the cassette base.</p> <p>When two mini gels are transferred simultaneously on a midi format stack, ensure the gels are arranged foot-to-foot (low molecular weight portions of the gels are toward each other).</p>
NO LOAD DETECTED is displayed on the Run screen	<p>The unit is detecting the presence of a cassette, but current is not passing between the electrode plates. Ensure that the blotting assembly is positioned properly and is thick enough to contact both the anode and cathode plates.</p> <p>If using a custom buffer, the buffer may have an ion capacity that is too low or too high for efficient transfer. Check the concentrations of components in the buffer.</p> <p>The electrical contacts on the cassette or instrument may be dirty. With the instrument unplugged, clean the contacts with a cotton swab or wipe moistened with isopropyl alcohol.</p>

---

## Overview of the Three Protocol Modes

**TURBO:** 1 or 2 mini format gels, or 1 midi format gel in 7 min;  
 1 Mini-PROTEAN TGX Gel in 3 min.

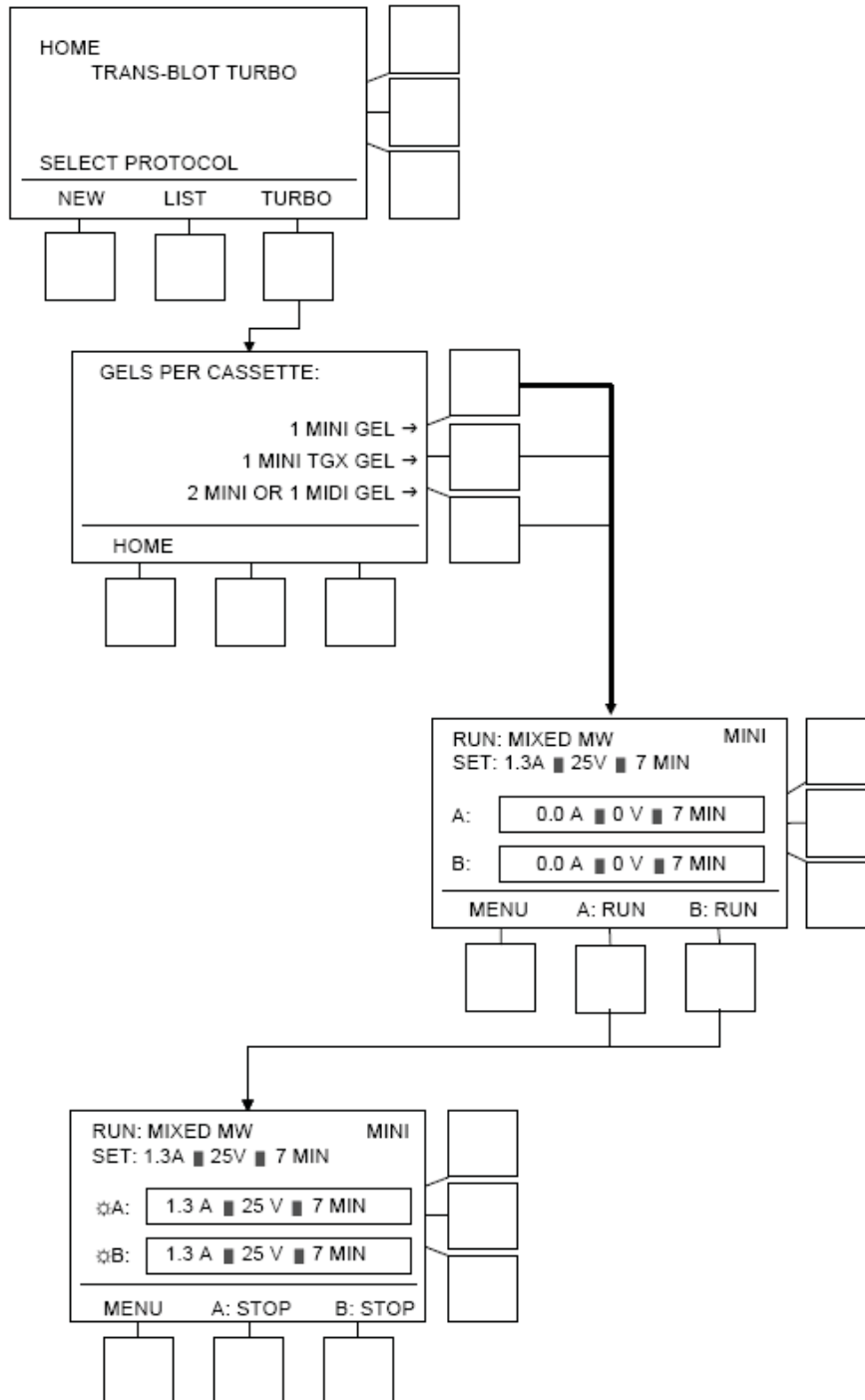

**LIST:** Bio-Rad preprogrammed protocols or user-defined protocols.

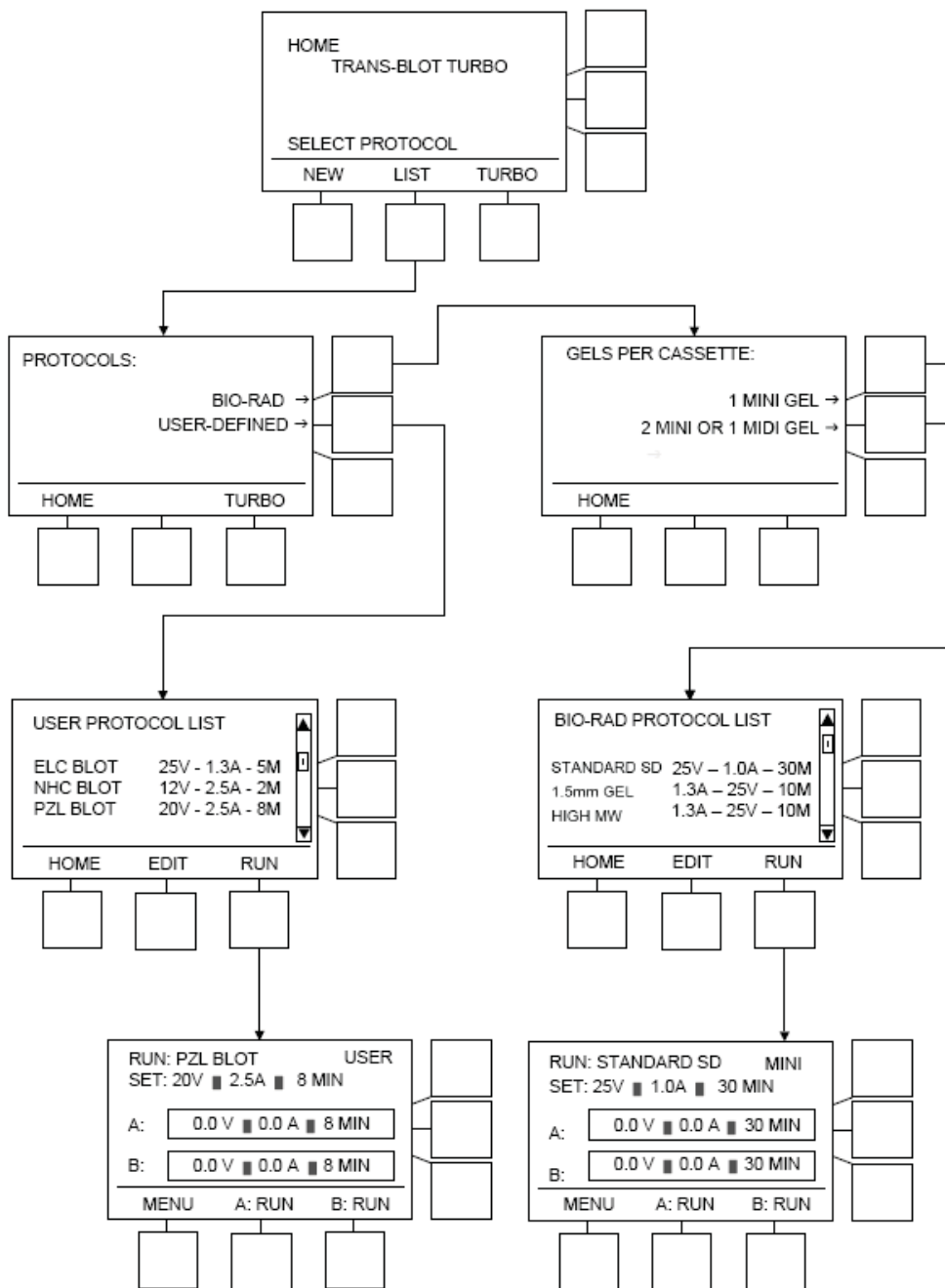

**NEW:** User can edit protocol parameters and name, save, and run the protocol.

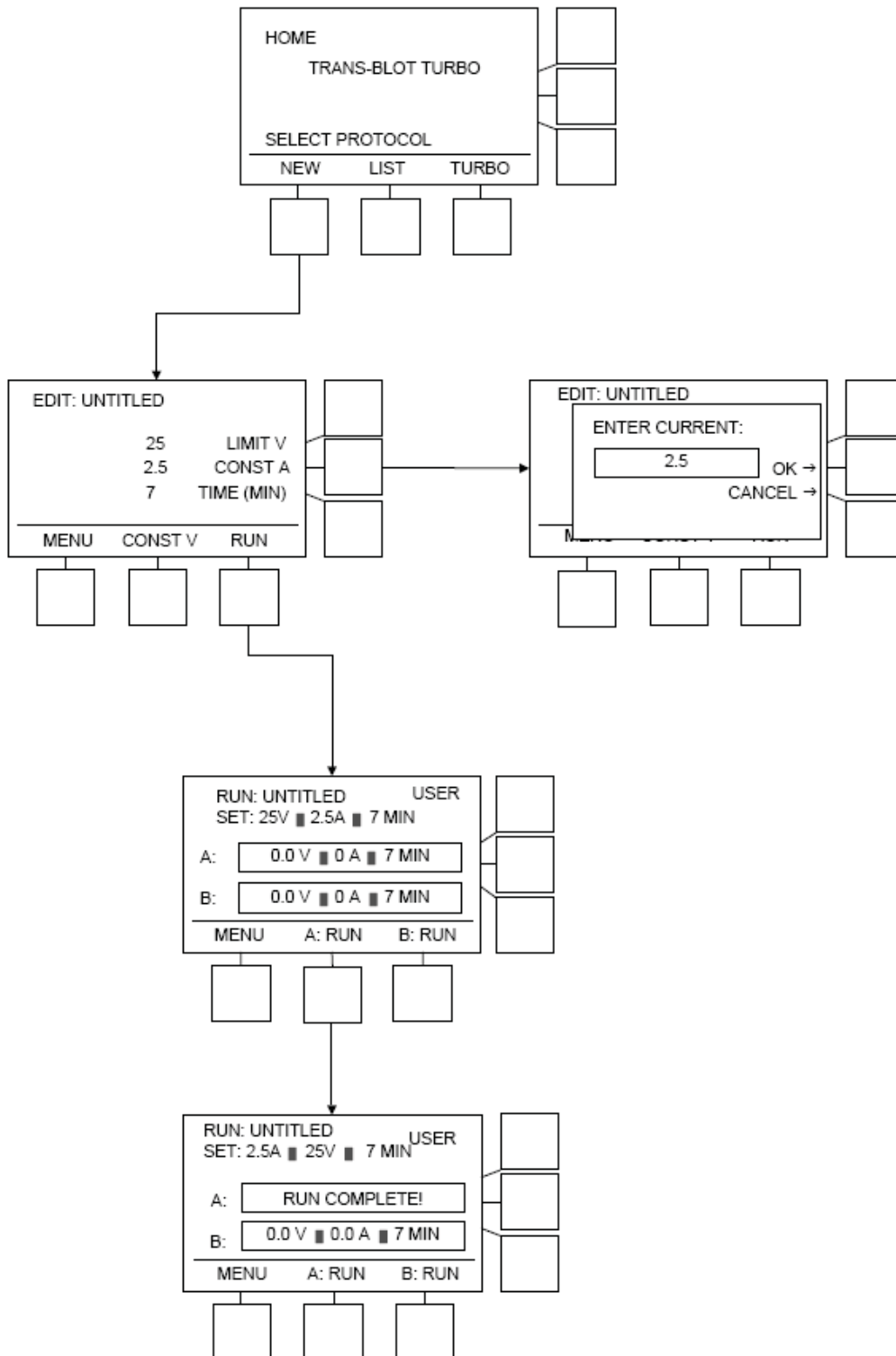

## Consumables and Related Products

Catalog #      Description

### Trans-Blot Turbo Accessories

1704151      Trans-Blot Turbo Cassette, single  
1704152      Trans-Blot Turbo Base

### Trans-Blot Turbo Starter Kits

Starter kits include a Trans-Blot Turbo instrument, a Trans-Blot Turbo Transfer Pack corresponding to the listed modifier, Precision Plus Protein WesternC Standards, and Precision Protein StrepTactin-HRP Conjugate.

17001917      Trans-Blot Turbo Starter Kit, mini PVDF  
17001919      Trans-Blot Turbo Starter Kit, midi PVDF  
17001918      Trans-Blot Turbo Starter Kit, mini nitrocellulose  
17001915      Trans-Blot Turbo Starter Kit, midi nitrocellulose

### Trans-Blot Turbo Transfer Packs

1704156      Trans-Blot Turbo Transfer Pack, 0.2 µm PVDF membrane, mini format, pack of 10  
1704157      Trans-Blot Turbo Transfer Pack, 0.2 µm PVDF membrane, midi format, pack of 10  
1704158      Trans-Blot Turbo Transfer Pack, 0.2 µm nitrocellulose membrane, mini format, pack of 10  
1704159      Trans-Blot Turbo Transfer Pack, 0.2 µm nitrocellulose membrane, midi format, pack of 10

### Trans-Blot Turbo RTA Transfer Kits

1704270      Trans-Blot Turbo RTA Transfer Kit, nitrocellulose, mini format (7.0 x 8.5 cm), for 40 blots  
1704271      Trans-Blot Turbo RTA Transfer Kit, nitrocellulose, midi format (8.5 x 13.5 cm), for 40 blots  
1704272      Trans-Blot Turbo RTA Transfer Kit, PVDF, mini format (7.0 x 8.5 cm), for 40 blots  
1704273      Trans-Blot Turbo RTA Transfer Kit, PVDF, midi format (8.5 x 13.5 cm), for 40 blots  
1704274      Trans-Blot Turbo RTA Transfer Kit, LF PVDF, mini format (7.0 x 8.5 cm), for 40 blots  
1704275      Trans-Blot Turbo RTA Transfer Kit, LF PVDF, midi format (8.5 x 13.5 cm), for 40 blots

### Related Products

1705060      Clarity Western ECL Substrate, 200 ml, includes 100 ml luminol/enhancer and 100 ml peroxide solution  
1705061      Clarity Western ECL Substrate, 500 ml, includes 250 ml luminol/enhancer reagent and 250 ml peroxide solution  
1705062      Clarity Max Western ECL Substrate, 100 ml, includes 50 ml luminol/enhancer reagent and 50 ml peroxide solution  
1705047      Immun-Star Goat Anti-Mouse (GAM)-HRP Conjugate  
1705046      Immun-Star Goat Anti-Rabbit (GAR)-HRP Conjugate  
1705010      Immun-Star GAM-AP Detection Kit, includes substrate, enhancer, GAM antibody  
1705011      Immun-Star GAR-AP Detection Kit, includes substrate, enhancer, GAR antibody  
1708238      Amplified Opti-4CN Substrate Kit, includes substrate, diluent, blocker, PBS  
1706515      Blotting-Grade Conjugate, goat anti-rabbit IgG (H+L)-HRP, 2 ml  
1706516      Blotting-Grade Conjugate, goat anti-mouse IgG (H+L)-HRP, 2 ml  
1706404      Blotting-Grade Blocker, nonfat dry milk, 300 g







**Bio-Rad  
Laboratories, Inc.**

Life Science  
Group

---

**Web site** [bio-rad.com](http://bio-rad.com) **USA** 1 800 424 6723 **Australia** 61 2 9914 2800 **Austria** 43 01 877 89019 **Belgium** 32 03 710 53 00  
**Brazil** 55 11 3065 7550 **Canada** 1 905 364 3435 **China** 86 21 6169 8500 **Czech Republic** 36 01 459 6192 **Denmark** 45 04 452 10 00  
**Finland** 35 08 980 422 00 **France** 33 01 479 593 00 **Germany** 49 089 3188 4393 **Hong Kong** 852 2789 3300 **Hungary** 36 01 459 6190  
**India** 91 124 4029300 **Israel** 972 03 963 6050 **Italy** 39 02 49486600 **Japan** 81 3 6361 7000 **Korea** 82 2 3473 4460 **Mexico** 52 555 488 7670  
**The Netherlands** 310 318 540 666 **New Zealand** 64 9 415 2280 **Norway** 47 0 233 841 30 **Poland** 36 01 459 6191 **Portugal** 351 21 4727717  
**Russia** 7 495 721 14 04 **Singapore** 65 6415 3188 **South Africa** 36 01 459 6193 **Spain** 34 091 49 06 580 **Sweden** 46 08 555 127 00  
**Switzerland** 41 0617 17 9555 **Taiwan** 886 2 2578 7189 **Thailand** 66 2 651 8311 **United Arab Emirates** 971 4 8187300  
**United Kingdom** 44 01923 47 1301

---

